

# **HF020 controller manual**

**(detailed version)**

## system introduction:

This is an operation control module specifically for stepping/servo motors. The module has no programmable function, but has a variety of fixed operating modes built-in, and users can quickly select a suitable motion track. You can save and set the distance/speed/delay/cycle times after power-off. It can run independently as a module, or cooperate with other systems as a third-party module to make up for the lack of motor output shaft!

### Suitable for the following industries:

1: Industrial automation control 2: Small mechanical equipment 3: Automatic painting industry 4: Rotary indexing tooling control

### Prohibited to be used in the following industries:

1: Medical equipment 2: Elevator, fire fighting, boiler equipment, power generation equipment, mining equipment and other special industries or life-critical fields

## System parameters:

Model	HF020	Operating Voltage	DC12-24V >1A
Size	99.7 x72 x17.0mm	Hole Size	92.0mm 69.8
Display	5 digits, highlight type digital tube	Pulse voltage	24V, 5-24V
working environment	-5°C-60°C	Pulse frequency	85K HZ
Output	2 ports output 。 The output voltage: 0V	Input	7 port inputs. The input takes 0V as the effective signal

# Chapter 1 Wiring Method

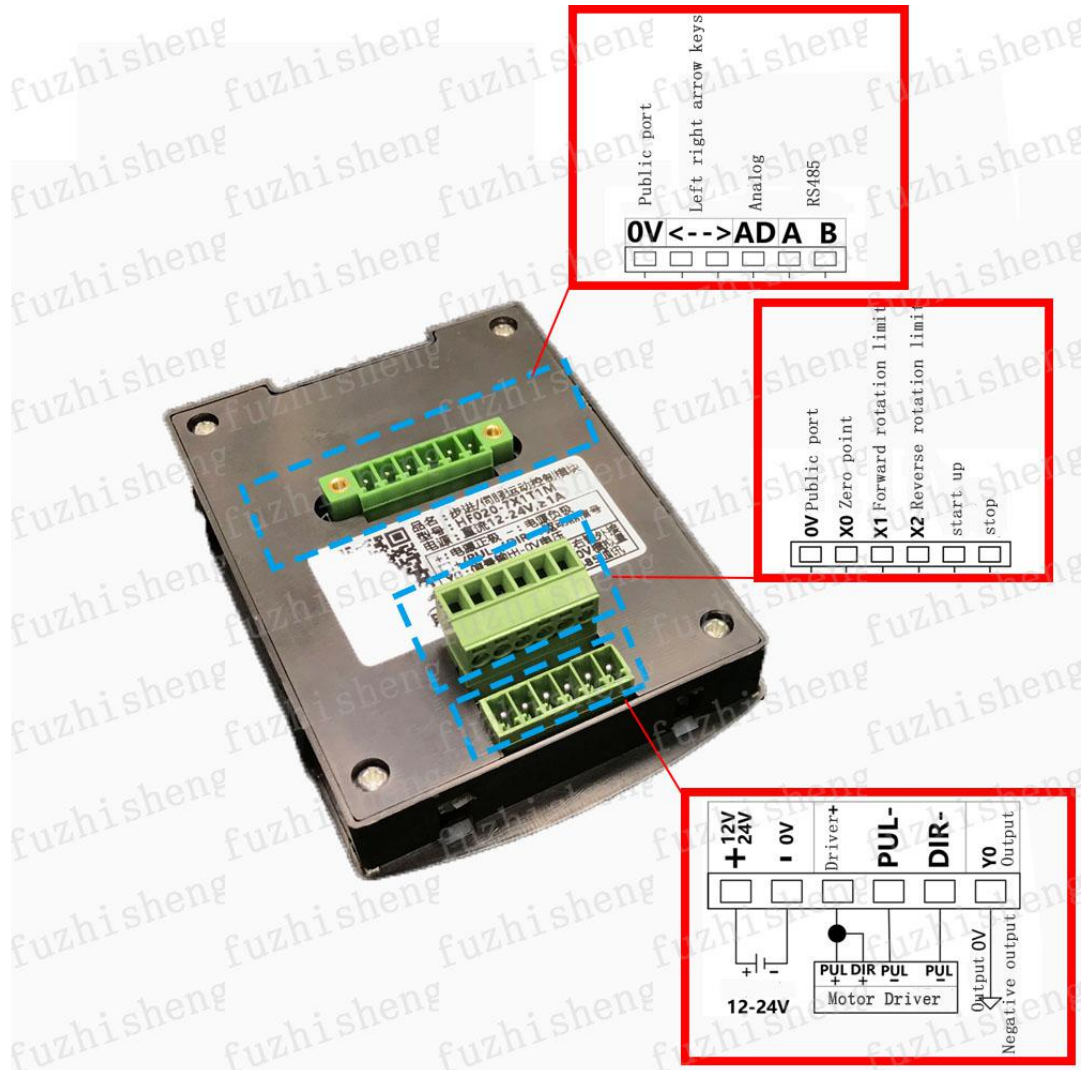

## 1.1 [Power source] [Step/Servo] [Y0 output] connection

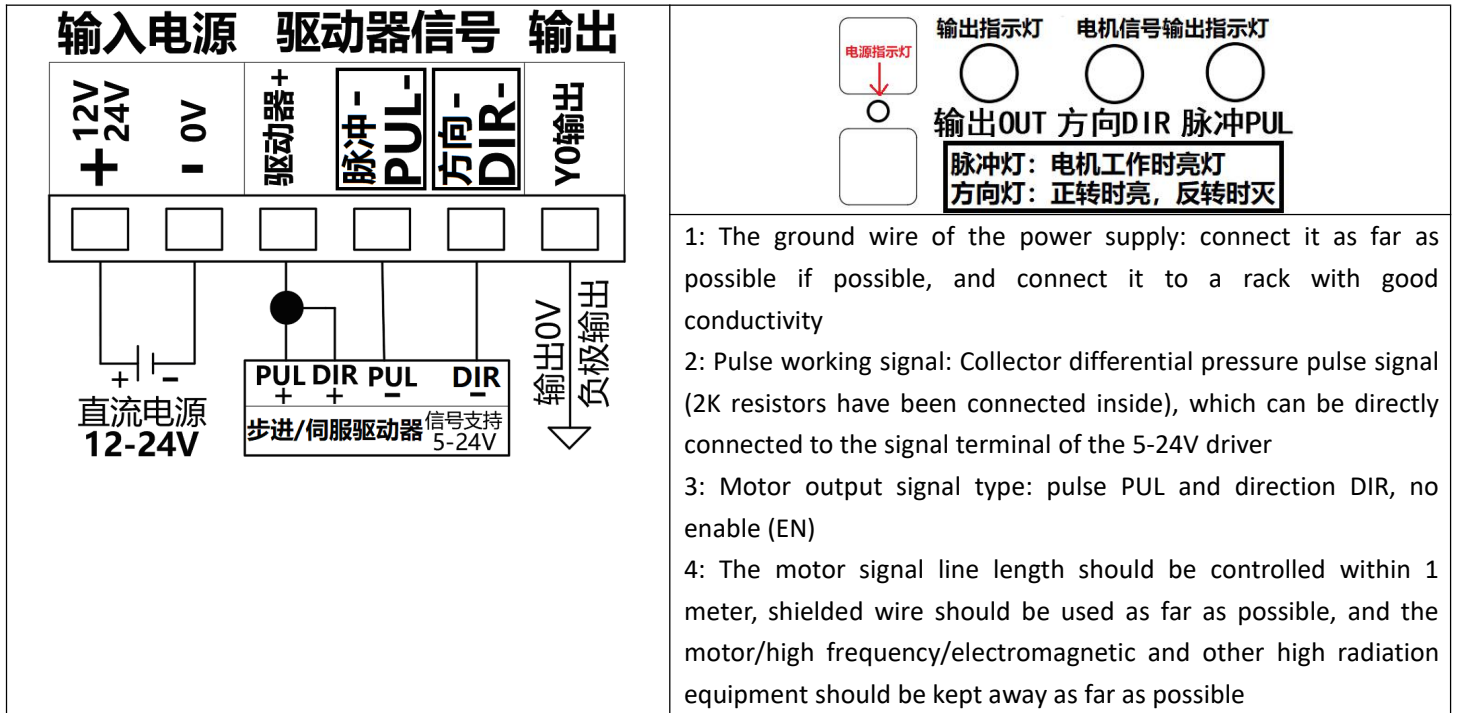

## 1.2 [Input signal] Wiring method

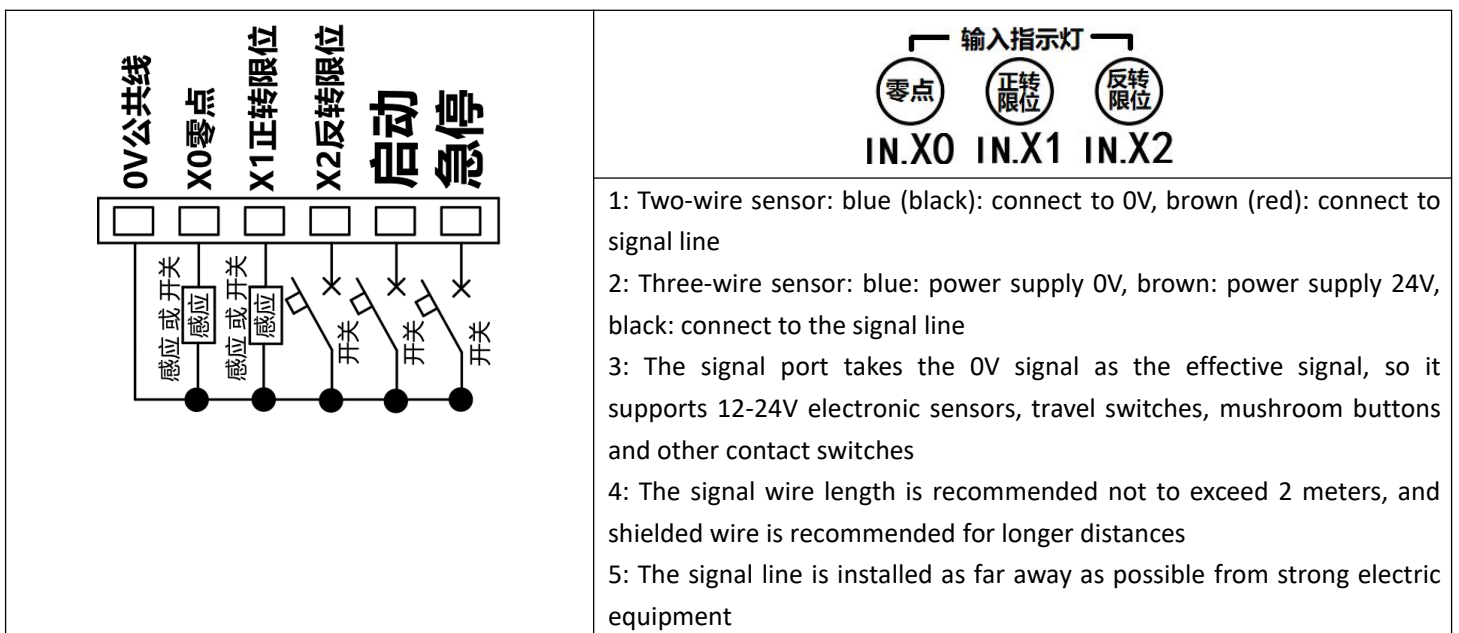

## 1.3 [Communications] [Left and right keys] [Y1 output] Wiring method

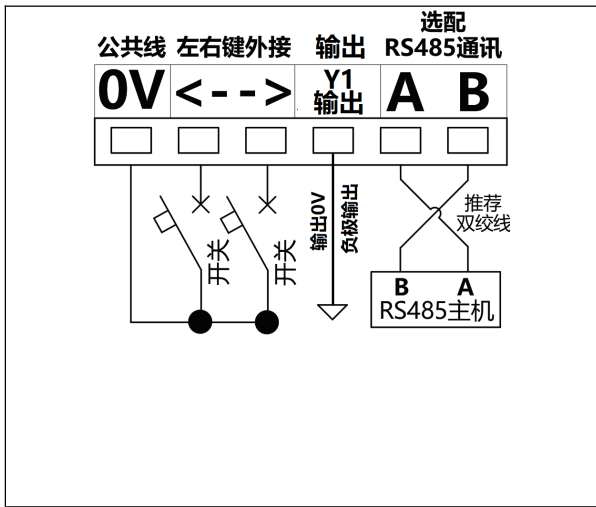

TX. 发送

RS485串口  
通讯指示灯

RX. 接收

- 1: External connection of left and right keys: It is the external connection of 【 Shift Left 】 【 Shift Right 】 on the controller panel. The method is the same as the input port
- 2: Output Y1: used to output the indication signal of working status. See the detailed introduction of P0 for specific actions. Output voltage 0V
- 3: The RS485 communication line should use twisted pair as far as possible.
- 4: All signal lines are installed as far away as possible from strong current equipment



# Chapter 3 [P] Function Introduction

## 3.1 List of all [P] functions

### 【P】 function introduction

NO.	Function	Adjustable range	Defaults
P0	Action flow mode selection	1-16	1
P1	Forward rotation distance (subject to gear ratio)	0.000~65535.999	10.000
P2	Forward speed	0-65535	01500
P3	Reversal distance (subject to gear ratio)	0.000~65535.999	10.000
P4	Reverse/zero speed	0-65535	01500
P5	Cycle work times (65535: countless times)	0-65534 or countless times	1
P6	Forward rotation delay	0.000~65535.999	0.000
P7	Reverse rotation delay	0.000~65535.999	0.000
P8	The speed when manually [shift key X+X-] is pressed	0-65535	01000

## 3.2 [P0: Action flow mode selection] List of all action flows

### 【P0】 Action flow mode selection

NO.	Function
P0→1	The motor follows [the button on the controller] to work
P0→2	Keep rotating after pressing the button
P0→3	It keeps rotating after pressing the button, and stops when it is released
P0→4	It keeps rotating after pressing the button, and it stops by pressing it again
P0→5	After pressing the button, it will rotate forward or reverse according to the set distance. (You can set the cycle)
P0→6	After pressing the button, it will rotate forward or return to zero according to the set distance. (Can be used for calibration)
P0→7	Always rotate forward or reverse, stop after hitting the limit, wait for the next start
P0→8	Cycle forward and reverse according to the set distance
P0→9	Cycle forward and return to zero according to the set distance
P0→10	Cycle forward and reverse between 2 limit switches
P0→11	When the start button is pressed for the first time, the motor rotates forward. Press the start button for the second time, the motor reverses
P0→12	When the start button is pressed for the first time, the motor rotates forward. Press the start button for the second time, the motor reverses or returns to zero
P0→13	The first time you press the start button, the motor reverses and stops when it hits the limit switch. Press the start button for the second time, the motor rotates forward and stops when it hits another limit switch
P0→14	Press the start button, the motor has been rotating forward, release the button, the motor will immediately reverse or return to zero
P0→15	Press the start button, the motor keeps rotating forward, then delays, and keeps looping like this. Press the start button again, the motor returns to zero
P0→16	Press the start button, the motor keeps rotating forward, then delays, and keeps looping like this. Press the start button again, the motor returns to zero
P0→17	Press the start button, press the set distance to rotate forward, release the start button, immediately reverse or return to zero
P0→18	Press the start button, press the set time forward and reverse

## 3.3 Detailed introduction of each action mode of [P0]

### 3.3.1 [P0→1] The motor follows the [knob on the controller] to work.

1. Detailed description of the function: Turn the [knob on the controller], the motor will follow the set distance and speed

Output: Y0 output when the motor is rotating forward. When the motor reverses, Y1 is output. The motor stops and the output is disconnected!

Manual function: Press [or] to move the motor manually

2. Effective introduction of corresponding parameter functions:

<b>【 P1 】 Forward distance</b>	✓	<b>【P2】 Forward speed</b>	✓	<b>【 P3 】 Reversal distance</b>	✓	<b>【 P4 】 Reverse/zero speed</b>	✓
<b>【P5】Cycle work times</b>	×	<b>【 P6 】 Forward rotation delay</b>	×	<b>【 P7 】 Reverse in-position delay</b>	×	<b>【P8】 Manual speed</b>	✓

3. Button functions on the panel:

	The motor follows the knob forward and reverse	 左移位 X-  右移位 X+	Manual motor moves left and right	 启动 RUN	no use	 急停 STOP	Emergency stop	 确认 ENT	This mode does not support speed saving
-------------------------------------------------------------------------------------	------------------------------------------------	---------------------------------------------------------------------------------------------------------------------------------------------------------------------------------------	-----------------------------------	--------------------------------------------------------------------------------------------	--------	----------------------------------------------------------------------------------------------	----------------	----------------------------------------------------------------------------------------------	-----------------------------------------

4. Effective introduction of the wiring port:

<b>【X0】 Motor zero</b>	×	<b>【X1】Forward rotation limit</b>	✓	<b>【X2】 Reverse limit</b>	✓	<b>Start port</b>	×
<b>【&lt;-】 Left key</b>	✓	<b>【-&gt;】 Right key</b>	✓	<b>【AB】 RS485 serial port</b>	选配	<b>Emergency stop port</b>	✓

### 3.3.2 [P0→2] keep rotating after pressing the button

1. Detailed introduction of the function:

Press **【<X-】** : Y0 signal is output-the motor keeps running in reverse at the set speed. The motor stops and the output is disconnected



Press **【x+】** or start key]: Y1 signal is output-the motor keeps rotating forward at the set speed. The motor stops and the output is disconnected

2. Effective introduction of corresponding parameter functions:

<b>【 P1 】</b> Forward distance	×	<b>【P2】 Forward speed</b>	✓	<b>【 P3 】</b> Reversal distance	×	<b>【 P4 】</b> Reverse/zero speed	✓
<b>【P5】</b> Cycle work times	×	<b>【 P6 】</b> Forward rotation delay	×	<b>【 P7 】</b> Reverse in-position delay	×	<b>【P8】</b> Manual speed	×

3. Button functions on the panel:

	Modify speed during operation		<b>Run reverse</b>	 或 	<b>Run forward</b>		Emergency stop		Save the modified speed during running
-----------------------------------------------------------------------------------	-------------------------------	-----------------------------------------------------------------------------------	--------------------	-----------------------------------------------------------------------------------------------------------------------------------------------------------------------	--------------------	-------------------------------------------------------------------------------------	----------------	-------------------------------------------------------------------------------------	----------------------------------------

4. Wiring port introduction:

<b>【X0】</b> Motor zero	×	<b>【 X1 】</b> Forward rotation limit	✓	<b>【X2】</b> Reverse limit	✓	<b>Start port</b>	✓
<b>【&lt;-】</b> Left key	✓	<b>【-&gt;】</b> Right key	✓	<b>【 AB 】</b> RS485 serial port	Optiona l	<b>Emergency stop port</b>	✓

**3.3.3 【P0→3】** It keeps rotating after pressing the button, and it stops when it is released.

1. Detailed introduction of functions:

Press **【<x-】** : output Y0 signal---motor keeps reverse rotation at the set speed---release **【<x-】** ---motor stop---output Y0 is closed.

Press**【x+】** or start key]:Output Y1 signal-the motor keeps rotating forward at the set speed-release the [or start key]-the motor stops-the output Y1 is closed.

2. Effective introduction of corresponding parameter functions:

<b>【 P1 】</b> Forward distance	×	<b>【P2】 Forward speed</b>	✓	<b>【 P3 】</b> Reversal distance	×	<b>【 P4 】</b> Reverse/zero speed	✓
--------------------------------	---	---------------------------	---	---------------------------------	---	----------------------------------	---

【P5】Cycle work times	×	【 P6 】 Forward rotation delay	×	【 P7 】 Reverse in-position delay	×	【P8】 Manual speed	×
----------------------	---	-------------------------------	---	----------------------------------	---	-------------------	---

### 3. Button functions on the panel:

	Modify speed during operation		Run reverse	 或 	Run forward		Emergency stop		Save the modified speed during running
-----------------------------------------------------------------------------------	-------------------------------	-----------------------------------------------------------------------------------	-------------	-----------------------------------------------------------------------------------------------------------------------------------------------------------------------	-------------	-------------------------------------------------------------------------------------	----------------	-------------------------------------------------------------------------------------	----------------------------------------

### 4. Wiring port introduction:

【X0】 Motor zero	×	【 X1 】 Forward rotation limit	✓	【X2】 Reverse limit	✓	Start port	✓
【<-】 Left key	✓	【->】 Right key	✓	【 AB 】 RS485 serial port	Optiona l	Emergency stop port	✓

### 3.3.4 [P0→4] After pressing the button, it keeps rotating, press it again to stop

#### 1. Detailed introduction of functions:

Press 【<x-】 : Output Y0 signal--motor keeps reverse rotation at the set speed---press 【<x-】 ---motor stop---output Y0 is off.

Press 【x+▶or start key】 :Output Y1 signal--motor keeps rotating forward at the set speed---press [x+▶or start key] again---motor stops---output Y1 is closed.

#### 2. Effective introduction of corresponding parameter functions:

【 P1 】 Forward distance	×	【P2】 Forward speed	✓	【 P3 】 Reversal distance	×	【 P4 】 Reverse/zero speed	✓
【P5】Cycle work times	×	【 P6 】 Forward rotation delay	×	【 P7 】 Reverse in-position delay	×	【P8】 Manual speed	×

### 3. Button functions on the panel:

	Modify speed during operation		Run reverse	 或 	Run forward		Emergency stop		Save the modified speed during running
-------------------------------------------------------------------------------------	-------------------------------	-------------------------------------------------------------------------------------	-------------	---------------------------------------------------------------------------------------------------------------------------------------------------------------------------	-------------	---------------------------------------------------------------------------------------	----------------	---------------------------------------------------------------------------------------	----------------------------------------

#### 4. Wiring port introduction:

<b>【X0】 Motor zero</b>	×	<b>【 X1 】 Forward rotation limit</b>	✓	<b>【X2】 Reverse limit</b>	✓	<b>Start port</b>	✓
<b>【&lt;-】 Left key</b>	✓	<b>【-&gt;】 Right key</b>	✓	<b>【 AB 】 RS485 serial port</b>	Optiona l	<b>Emergency stop port</b>	✓

### 3.3.5 [P0→5] According to the set distance forward or reverse rotation.

#### 1. Detailed introduction of functions:





Press【<-】: Output Y1 is on --- The motor reverses according to the set distance and speed --- Output Y1 is off --- Output Y0 is on --- Reverse end delay --- Output Y0 is off, waiting for the next start . The above can be recycled

Press [x+▶or start key]: Output Y1 is on---Motor rotates forward according to the set distance and speed---Output Y1 is off---Output Y0 is on---forward turn to position delay---output Y0 is off, etc. Start next time. The above can be recycled

#### 2. Effective introduction of corresponding parameter functions:

<b>【 P1 】 Forward distance</b>	✓	<b>【P2】 Forward speed</b>	✓	<b>【 P3 】 Reversal distance</b>	✓	<b>【 P4 】 Reverse/zero speed</b>	✓
<b>【P5】Cycle work times</b>	✓	<b>【 P6 】 Forward rotation delay</b>	✓	<b>【 P7 】 Reverse in-position delay</b>	✓	<b>【P8】 Manual speed</b>	×

#### 3. Button functions on the panel:

	Modify speed during operation		<b>Run reverse</b>	 或 	<b>Run forward</b>		Emerg ency stop		Save the modified speed during running
-------------------------------------------------------------------------------------	-------------------------------	-------------------------------------------------------------------------------------	--------------------	---------------------------------------------------------------------------------------------------------------------------------------------------------------------------	--------------------	---------------------------------------------------------------------------------------	-----------------------	---------------------------------------------------------------------------------------	----------------------------------------

#### 4. Wiring port introduction:

【X0】 Motor zero	×	【 X1 】 Forward rotation limit	✓	【X2】 Reverse limit	✓	Start port	✓
【<-】 Left key	✓	【->】 Right key	✓	【 AB 】 RS485 serial port	Optiona l	Emergency stop port	✓

**3.3.6【P0→6】according to the set distance forward or return to zero (calibration function can be enabled).**

1. Detailed introduction of functions:

Press 【<x-】: Output Y1 is on --- The motor reverses to zero according to the set speed --- Output Y1 is off --- Output Y0 is on --- Reverse end delay --- Output Y0 is off, waiting for the next start. The above is not recyclable

Press [x+▶or start key]: Output Y1 is on---Motor rotates forward according to the set distance and speed---Output Y1 is off---Output Y0 is on---forward turn to position delay---output Y0 is off, etc. Start next time. The above can be recycled

2. Effective introduction of corresponding parameter functions:

【 P1 】 Forward distance	✓	【P2】 Forward speed	✓	【 P3 】 Reversal distance	×	【 P4 】 Reverse/zero speed	✓
【P5】Cycle work times	✓	【 P6 】 Forward rotation delay	✓	【 P7 】 Reverse in-position delay	✓	【P8】 Manual speed	×

3. Button functions on the panel:

	Modify speed during operation		Run reverse	 或 	Run forward		Emergency stop		Save the modified speed during running
-------------------------------------------------------------------------------------	-------------------------------	-------------------------------------------------------------------------------------	-------------	---------------------------------------------------------------------------------------------------------------------------------------------------------------------------	-------------	---------------------------------------------------------------------------------------	----------------	---------------------------------------------------------------------------------------	----------------------------------------

4. Wiring port introduction:

【X0】 Motor zero	Turn on according to the situation	【 X1 】 Forward rotation limit	✓	【X2】 Reverse limit	✓	Start port	✓
-----------------	------------------------------------	-------------------------------	---	--------------------	---	------------	---

【<-】 Left key	✓	【->】 Right key	✓	【 AB 】 RS485 serial port	Optiona l	Emergency stop port	✓
---------------	---	----------------	---	--------------------------	--------------	---------------------	---

5. About the introduction of the motor zero point: In the default setting, the zero point is used for the software zero point. Mode can be selected under 【F5-F8】 function

### 3.3.7 【P0→7】 Forward rotation (reverse rotation) permanent rotation-limit stop-stop-wait for next start

1. Detailed introduction of functions:

Press 【<x-】 : output Y1 signal---motor reverses at the set speed---touches the limit switch 【X2】 ---motor stops---output Y1 is off---output Y0 is on---reverse Arrival delay---output Y0 is off, waiting for the next start. The above can be recycled

Press 【x+▶or start key】 : output Y1 signal--motor rotates forward at the set speed---touch the limit switch 【X1】 ---motor stops---output Y1 is off---output Y0 is on--- Forward to the position delay --- output Y0 off, waiting for the next start. The above can be recycled

2. Effective introduction of corresponding parameter functions:

【 P1 】 Forward distance	×	【P2】 Forward speed	✓	【 P3 】 Reversal distance	×	【 P4 】 Reverse/zero speed	✓
【P5】Cycle work times	✓	【 P6 】 Forward rotation delay	×	【 P7 】 Reverse in-position delay	×	【P8】 Manual speed	×

3. Button functions on the panel:

	Modify speed during operation		Run reverse	 或 	Run forward		Emergency stop		Save the modified speed during running
-------------------------------------------------------------------------------------	-------------------------------	-------------------------------------------------------------------------------------	-------------	---------------------------------------------------------------------------------------------------------------------------------------------------------------------------	-------------	---------------------------------------------------------------------------------------	----------------	---------------------------------------------------------------------------------------	----------------------------------------

#### 4. Wiring port introduction:

【X0】 Motor zero	×	【 X1 】 Forward rotation limit	✓	【X2】 Reverse limit	✓	Start port	✓
【<-】 Left key	✓	【->】 Right key	✓	【 AB 】 RS485 serial port	Optiona l	Emergency stop port	✓

#### 3.3.8 [P0→8] Cycle forward and reverse according to the set distance.

1. Function details: Manual function: Press [**x** or **x+**] to move the motor manually

Press [Start Key]: Output Y1 is on---Motor rotates forward according to the setting

[distance] and [speed]---output Y1 is off---output Y0 is on---forward rotation to

position delay---output Y0 is off . Output Y1 is on---then the motor reverses





according to the setting [distance] and [speed]---output Y1 is off---output Y0 is

on---reverse end delay---output Y0 is off. Cycle above N times

2. Effective introduction of corresponding parameter functions:

【 P1 】 Forward distance	✓	【P2】 Forward speed	✓	【 P3 】 Reversal distance	✓	【 P4 】 Reverse/zero speed	✓
【P5】Cycle work times	✓	【 P6 】 Forward rotation delay	✓	【 P7 】 Reverse in-position delay	✓	【P8】 Manual speed	✓

#### 3. Button functions on the panel:

	Modify speed during operation		Manual motor moves left and right		Run		Emergency stop		Save the modified speed during running
-------------------------------------------------------------------------------------	-------------------------------	-------------------------------------------------------------------------------------	-----------------------------------	-------------------------------------------------------------------------------------	-----	--------------------------------------------------------------------------------------	----------------	---------------------------------------------------------------------------------------	----------------------------------------

#### 4. Wiring port introduction:

【X0】 Motor zero	×	【 X1 】 Forward rotation limit	✓	【X2】 Reverse limit	✓	Start port	✓
【<-】 Left key	✓	【->】 Right key	✓	【 AB 】 RS485 serial port	Optiona l	Emergency stop port	✓

### 3.3.9 [P0→9] Cycle forward and return to zero according to the set distance

1. Function details: Manual function: Press **[←x-orx+→]** to move the motor manually

Press **【Start Key】** : The motor will reverse to zero first, and then it will start to work normally. Output Y1 is on---The motor rotates forward according to the setting [distance] and [speed]---output Y1 is off---output Y0 is on---forward turn to position delay---output Y0 is off. Output Y1 is on---The motor reverses to zero according to the setting [Speed]---Output Y1 is off---output Y0 is on---reverse end delay---output Y0 is off. The above cycle.

2. Effective introduction of corresponding parameter functions:

<b>【 P1 】 Forward distance</b>	✓	<b>【P2】 Forward speed</b>	✓	<b>【 P3 】 Reversal distance</b>	×	<b>【 P4 】 Reverse/zero speed</b>	✓
<b>【P5】Cycle work times</b>	✓	<b>【 P6 】 Forward rotation delay</b>	✓	<b>【 P7 】 Reverse in-position delay</b>	✓	<b>【P8】 Manual speed</b>	✓

3. Button functions on the panel:

	Modify speed during operation	 左移位 x-	 右移位 x+	Manual motor moves left and right	 启动 RUN	Run	 急停 STOP	Emergency stop	 确认 ENT	Save the modified speed during running
-------------------------------------------------------------------------------------	-------------------------------	-----------------------------------------------------------------------------------------------	-----------------------------------------------------------------------------------------------	-----------------------------------	-----------------------------------------------------------------------------------------------	-----	-------------------------------------------------------------------------------------------------	----------------	-------------------------------------------------------------------------------------------------	----------------------------------------

4. Wiring port introduction:

<b>【X0】 Motor zero</b>	Turn on according to the situation	<b>【 X1 】 Forward rotation limit</b>	✓	<b>【X2】 Reverse limit</b>	✓	Start port	✓
<b>【&lt;-】 Left key</b>	✓	<b>【-&gt;】 Right key</b>	✓	<b>【 AB 】 RS485 serial port</b>	Optiona l	Emergency stop port	✓

5. About the introduction of the motor zero point: In the default setting, the zero point is used for the software zero point. Mode can be selected under 【 F5-F8 】 function

### **3.3.10 【P0→10】 Cycle forward and reverse between 2 limit switches**

1. Function details: Manual function: Press [◀x-orx▶] to move the motor manually  
Press the [Start Key]: the motor reverses first to find [X0 zero limit switch], and then it starts to work normally.

Output Y1 is on---The motor rotates forward according to the setting [Speed]---It touches the [forward rotation limit switch X1]---The motor stops---output Y1 is off.

Output Y0 is on---forward turn to bit delay---output Y0 is off. Output Y1 is on---motor reverses according to the setting [speed]---touches [reverse limit switch X0]---motor stops---output Y1 is off---output Y0 is on---reverse Arrival delay---output Y0 is off. The above cycle is N times.

Precautions:

If the motor runs at high speed and stops when it hits the limit switch, it will have a great impact. The reason is the same as when a car suddenly brakes. In order to solve this problem, we adopted a reasonable method: the motor first reaches a certain distance quickly --- and then decelerates, and then finds the limit switch at a slow speed --- stops when it hits the limit switch. The first time the motor is rotating forward, I don't know where the limit switch is installed, so it will quickly hit the limit switch and have an impact. After that, the system will automatically adjust the fast and slow distances. The limit switch is effective regardless of whether it is fast or



slow. In other words, no matter what the situation is, as long as the limit switch is touched, the motor will stop.

2. Effective introduction of corresponding parameter functions:







<b>【 P1 】 Forward distance</b>	×	<b>【 P2 】 Forward speed</b>	✓	<b>【 P3 】 Reversal distance</b>	×	<b>【 P4 】 Reverse/zero speed</b>	✓
<b>【 P5 】 Cycle work times</b>	✓	<b>【 P6 】 Forward rotation delay</b>	✓	<b>【 P7 】 Reverse in-position delay</b>	✓	<b>【 P8 】 Manual speed</b>	✓

Parameter introduction: [P2] Forward speed at fast speed [P4] Reverse speed at fast

speed [F6] Speed for slow forward and reverse rotation

**【 F5 】** Slow running distance

3. Button functions on the panel:

	Modify speed during operation	 	Manual motor moves left and right		Run		Emergency stop		Save the modified speed during running
-------------------------------------------------------------------------------------	-------------------------------	-------------------------------------------------------------------------------------------------------------------------------------------------------------------------	-----------------------------------	-------------------------------------------------------------------------------------	-----	--------------------------------------------------------------------------------------	----------------	---------------------------------------------------------------------------------------	----------------------------------------

4. Wiring port introduction:

<b>【 X0 】 Motor zero</b>	✓	<b>【 X1 】 Forward rotation limit</b>	✓	<b>【 X2 】 Reverse limit</b>	✓	Start port	✓
<b>【 &lt;-&gt; 】 Left key</b>	✓	<b>【 -&gt; 】 Right key</b>	✓	<b>【 AB 】 RS485 serial port</b>	Optional	Emergency stop port	✓

### 3.3.11 【 P0→11】 Press the 【 Start key】 to rotate forward, then press the 【 Start key】 to reverse

1. Function details: Manual function: Press [**x- or x+**] to move the motor manually

Press [Start Key]: Output Y1 is on---Motor runs forward according to the set







[distance] and [speed]---output Y1 is off---output Y0 is on---forward rotation to

position delay---output Y0 turn off. Press the [Start Key] again: Output Y1 is on---The motor runs in reverse according to the setting [Distance] and [Speed]---Output Y1 is off---Output Y0 is on---reverse end delay---output Y0 is off.

2. Effective introduction of corresponding parameter functions:

<b>【 P1 】 Forward distance</b>	✓	<b>【P2】 Forward speed</b>	✓	<b>【 P3 】 Reversal distance</b>	✓	<b>【 P4 】 Reverse/zero speed</b>	✓
<b>【P5】Cycle work times</b>	×	<b>【 P6 】 Forward rotation delay</b>	✓	<b>【 P7 】 Reverse in-position delay</b>	✓	<b>【P8】 Manual speed</b>	✓

3. Button functions on the panel:

	Modify speed during operation	 	Manual motor moves left and right		Run		Emergency stop		Save the modified speed during running
-----------------------------------------------------------------------------------	-------------------------------	---------------------------------------------------------------------------------------------------------------------------------------------------------------------	-----------------------------------	-----------------------------------------------------------------------------------	-----	------------------------------------------------------------------------------------	----------------	-------------------------------------------------------------------------------------	----------------------------------------

4. Wiring port introduction:

<b>【X0】 Motor zero</b>	×	<b>【 X1 】 Forward rotation limit</b>	✓	<b>【X2】 Reverse limit</b>	✓	<b>Start port</b>	✓
<b>【&lt;-】 Left key</b>	✓	<b>【-&gt;】 Right key</b>	✓	<b>【 AB 】 RS485 serial port</b>	Optiona l	<b>Emergency stop port</b>	✓



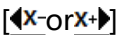

### 3.3.12 [P0→12] Press [Start]: forward rotation, then press [Start]: reverse and return to zero (calibration possible)

1. Function details: Manual function: Press  to move the motor manually  
 Press **【Start Key】** : The motor will reverse to zero first, and then it will start to work normally. Output Y1 is on---Motor runs forward according to the setting [distance] and [speed]---output Y1 is off---output Y0 is on---forward rotation is delayed---output Y0 is off. Press the [Start key] again: Output Y1 is on---The motor runs in reverse and returns to zero according to the set [speed]---Output Y1 is off---Output Y0 is on---Reverse arrival delay---Output Y0 is off .

2. Effective introduction of corresponding parameter functions:

【 P1 】 Forward distance	✓	【 P2 】 Forward speed	✓	【 P3 】 Reversal distance	×	【 P4 】 Reverse/zero speed	✓
【 P5 】 Cycle work times	×	【 P6 】 Forward rotation delay	✓	【 P7 】 Reverse in-position delay	✓	【 P8 】 Manual speed	✓

3. Button functions on the panel:

	Modify speed during operation		Manual motor moves left and right		Run		Emergency stop		Save the modified speed during running
-----------------------------------------------------------------------------------	-------------------------------	-----------------------------------------------------------------------------------	-----------------------------------	-----------------------------------------------------------------------------------	-----	------------------------------------------------------------------------------------	----------------	-------------------------------------------------------------------------------------	----------------------------------------

#### 4. Wiring port introduction:

【 X0 】 Motor zero	Turn on according to the situation	【 X1 】 Forward rotation limit	✓	【 X2 】 Reverse limit	✓	Start port	✓
【 <-> 】 Left key	✓	【 -> 】 Right key	✓	【 AB 】 RS485 serial port	Optional	Emergency stop port	✓

3.3.13【P0→13】Press the【Start key】to reverse to the limit switch and stop. Press 【start key】 again to turn to another limit switch to stop

1. Function details: Manual function: Press 【<-或->】 to move the motor manually  
 Press the [Start Key]: Output Y1 is turned on---The motor reverses according to the setting [speed]---It touches the [Reverse limit switch X0]---The motor stops---The output Y1 is off, and the output Y0 is on --Reverse end delay---Output Y0 is off.  
 Press [Start Key] again, output Y1 is turned on --- the motor rotates forward according to the setting [speed] --- it touches the [forward rotation limit switch X1] --- the motor stops --- the output Y1 is off, and the output Y0 is on ---Positive rotation delay---Output Y0 is off.







Precautions:

If the motor runs at high speed and stops when it hits the limit switch, it will have a great impact. The reason is the same as when a car suddenly brakes. In order to solve this problem, we adopted a reasonable method: the motor first reaches a certain distance quickly --- and then decelerates, and then finds the limit switch at a slow speed --- stops when it hits the limit switch. The first time the motor is rotating forward, I don't know where the limit switch is installed, so it will quickly hit the limit switch and have an impact. After that, the system will automatically adjust the fast and slow distances. The limit switch is effective regardless of whether it is fast or slow. In other words, no matter what the situation is, as long as the limit switch is touched, the motor will stop.

2. Effective introduction of corresponding parameter functions:

【 P1 】 Forward distance	×	【 P2 】 Forward speed	✓	【 P3 】 Reversal distance	×	【 P4 】 Reverse/zero speed	✓
【 P5 】 Cycle work times	×	【 P6 】 Forward rotation delay	✓	【 P7 】 Reverse in-position delay	✓	【 P8 】 Manual speed	✓

3. Button functions on the panel:

	Modify speed during operation	 	Manual motor moves left and right		Run		Emergency stop		Save the modified speed during running
-------------------------------------------------------------------------------------	-------------------------------	-------------------------------------------------------------------------------------------------------------------------------------------------------------------------	-----------------------------------	-------------------------------------------------------------------------------------	-----	--------------------------------------------------------------------------------------	----------------	---------------------------------------------------------------------------------------	----------------------------------------

4. Wiring port introduction:

【 X0 】 Motor zero	✓	【 X1 】 Forward rotation limit	✓	【 X2 】 Reverse limit	✓	Start port	✓
【 <- 】 Left key	✓	【 -> 】 Right key	✓	【 AB 】 RS485 serial	Optiona	Emergency stop	✓

				port	I	port	
--	--	--	--	------	---	------	--





### 3.3.14 【P0→14】 Start: the motor rotates forward forever-release [start]-the motor reverses to zero

1. Function details: Manual function: Press **【←或→】** to move the motor manually  
 Press **【Start Key】** : The motor will reverse to zero first, and then it will start to work normally. The motor runs forward according to the set [speed]---release the [start key]---the motor stops forward rotation---output Y0 is turned on---forward turn to position delay---output Y0 is off---motor follows Set [Speed] reverse return to zero---output Y1 on---reverse end delay---output Y1 off.

2. Effective introduction of corresponding parameter functions:

<b>【 P1 】 Forward distance</b>	×	<b>【P2】 Forward speed</b>	✓	<b>【 P3 】 Reversal distance</b>	×	<b>【 P4 】 Reverse/zero speed</b>	✓
<b>【P5】Cycle work times</b>	×	<b>【 P6 】 Forward rotation delay</b>	✓	<b>【 P7 】 Reverse in-position delay</b>	✓	<b>【P8】 Manual speed</b>	✓

3. Button functions on the panel:

	Modify speed during operation		Manual motor moves left and right		Run		Emergency stop		Save the modified speed during running
-------------------------------------------------------------------------------------	-------------------------------	-------------------------------------------------------------------------------------	-----------------------------------	-------------------------------------------------------------------------------------	-----	--------------------------------------------------------------------------------------	----------------	---------------------------------------------------------------------------------------	----------------------------------------

4. Wiring port introduction:

<b>【X0】 Motor zero</b>	Turn on according to the situation	<b>【 X1 】 Forward rotation limit</b>	✓	<b>【X2】 Reverse limit</b>	✓	<b>Start port</b>	✓
<b>【&lt;-】 Left key</b>	✓	<b>【-&gt;】 Right key</b>	✓	<b>【 AB 】 RS485 serial port</b>	Optional	<b>Emergency stop port</b>	✓

### 3.3.15【P0→15】【P0→16】forward rotation cycle N times --- then reverse to zero

1. Function details: Manual function: Press **【←或→】** to move the motor manually



**【P0-15】**: Press the **【Start key】**: the motor will reverse to zero first, and then it will start to work normally. Output Y1 open---according to the set [distance] [speed] forward rotation---output Y1 off---output Y0 on---forward rotation delay---output Y0 off---the above cycle N times (You don't need to press the [Start key] to cycle next time). After the cycle is over, press the [Start Key]-the motor reverses and returns to zero according to the set [speed]

[P0-16]: Press the [Start Key]: the motor first reverses and returns to zero, and then it starts to work normally. Output Y1 open---according to the set [distance] [speed] forward rotation---output Y1 off---output Y0 on---forward rotation delay---output Y0 off---the above cycle N times (Need to press [Start Key] again to cycle next time). After the cycle is over, press the [Start Key]-the motor reverses and returns to zero according to the set [speed]

2. Effective introduction of corresponding parameter functions:

<b>【 P1 】 Forward distance</b>	✓	<b>【P2】 Forward speed</b>	✓	<b>【 P3 】 Reversal distance</b>	×	<b>【 P4 】 Reverse/zero speed</b>	✓
<b>【P5】Cycle work times</b>	✓	<b>【 P6 】 Forward rotation delay</b>	✓	<b>【 P7 】 Reverse in-position delay</b>	×	<b>【P8】 Manual speed</b>	✓

3. Button functions on the panel:

	Modify speed during operation		Manual motor moves left and right		Run		Emergency stop		Save the modified speed during running
-------------------------------------------------------------------------------------	-------------------------------	-------------------------------------------------------------------------------------	-----------------------------------	-------------------------------------------------------------------------------------	-----	--------------------------------------------------------------------------------------	----------------	---------------------------------------------------------------------------------------	----------------------------------------

4. Wiring port introduction:

<b>【X0】 Motor zero</b>	Turn on according	<b>【 X1 】 Forward rotation limit</b>	✓	<b>【X2】 Reverse limit</b>	✓	<b>Start port</b>	✓
------------------------	-------------------	--------------------------------------	---	---------------------------	---	-------------------	---

	to the situation						
【<-】 Left key	√	【->】 Right key	√	【 AB 】 RS485 serial port	Optiona l	Emergency stop port	√

### 3.3.16 【P0→17】 Start-the motor rotates forward according to the set distance.

#### Release start-reverse return to zero

1. Function details: Manual function: Press 【←或→】 to move the motor manually

Press 【Start Key】 : The motor will reverse to zero first, and then it will start to work normally. The motor runs forward according to the setting [distance] [speed]-release the [start key]-the motor stops forward rotation-the output Y0 is on-the forward rotation delay-the output Y0 is off-the motor is in accordance with the setting [ Speed] Reverse return to zero---output Y1 on---reverse end delay---output Y1 off.

2. Effective introduction of corresponding parameter functions:

【 P1 】 Forward distance	√	【P2】 Forward speed	√	【 P3 】 Reversal distance	×	【 P4 】 Reverse/zero speed	√
【P5】Cycle work times	×	【 P6 】 Forward rotation delay	√	【 P7 】 Reverse in-position delay	√	【P8】 Manual speed	√

3. Wiring port introduction:

【X0】 Motor zero	Turn on according to the situation	【 X1 】 Forward rotation limit	√	【X2】 Reverse limit	√	Start port	√
【<-】 Left key	√	【->】 Right key	√	【 AB 】 RS485 serial port	Optiona l	Emergency stop port	√

4. About the introduction of the motor zero point: In the default setting, the zero point is used for the software zero point. Mode can be selected under 【F5-F8】 function

### 3.3.17 【P0→18】 According to the set time forward or reverse rotation.

1. Detailed introduction of functions:

Press 【X-】 : Output Y1 is on---The motor is in accordance with the set time 【P6 value】 : Reverse---output Y1 is off---output Y0 is on---delay 【P7 value】 ---output Y0 Turn off and wait for the next startup. The above can be cycled [P5 value]

Press [X+] or start key]: output Y1 is on --- the motor is in accordance with the set time [P6 value]: forward rotation --- output Y1 is off --- output Y0 is on---delayed [P7 value]-- -Output Y0 off, wait for the next startup. The above can be cycled [P5 value]

2. Effective introduction of corresponding parameter functions:

【 P1 】 Forward distance	×	【P2】 Forward speed	✓	【 P3 】 Reversal distance	×	【 P4 】 Reverse/zero speed	✓
【P5】Cycle work times	✓	【 P6 】 Forward rotation delay	✓	【 P7 】 Reverse in-position delay	✓	【P8】 Manual speed[	✓

3. Button functions on the panel:

	Modify speed during operation		Run reverse	 或 	Run forward		Emergency stop		Save the modified speed during running
-------------------------------------------------------------------------------------	-------------------------------	-------------------------------------------------------------------------------------	-------------	---------------------------------------------------------------------------------------------------------------------------------------------------------------------------	-------------	---------------------------------------------------------------------------------------	----------------	---------------------------------------------------------------------------------------	----------------------------------------

4. Wiring port introduction:

【X0】 Motor zero	×	【 X1 】 Forward rotation limit	✓	【X2】 Reverse limit	✓	Start port	✓
【<-】 Left key	✓	【->】 Right key	✓	【 AB 】 RS485 serial	Optiona	Emergency stop	✓



				port	I	port	
--	--	--	--	------	---	------	--

# Chapter 4 [F] Function Introduction

## 4.1 List of all [F] functions

[F] Summary of the function: In actual work, the parameters (internal parameters of the system) that do not need to be modified frequently are all concentrated here.

### [F] function introduction

NO.	Function	Adjustable range	Defaults
F1	Numerator (electronic gear ratio) How many pulses are needed for one revolution of the motor	0-65535	160
F2	Denominator (electronic gear ratio) How much um is equal to one revolution of the motor	0-65535	100
F3	Motor allowable minimum operating speed	0-65535	0
F4	Maximum allowable operating speed of the motor	0-65535	65535
F5	Zero position (useful when mechanical zero point)	0.000~65535.999	4.000
F6	The speed of finding the zero point	0-65535	800
F7	Search zero mode (0: software zero, 1-3: mechanical zero, 1 is recommended)	0-3	0
F8	Zero function start point	0.000~65534.999	65535.000
F9	Acceleration	0-65535	15000
F10	deceleration	0-65535	15000
F11			
F12			
F13	X0-X1-X2 input signal filter time	0-65535	25
F14	The range of speed change during operation	0-255	3
F15	Whether to automatically return to zero after power-on (0: NO, 1: Yes)	0-1	0

F16	Special function setting: (range value expressed in binary system) When the range value is all 0, it starts normally without opening any special functions. The default is 0. The last digit of the range value represents forcibly closing the speed change function, 1: Turn off the speed change function, 0: Turn on the speed change function The penultimate digit of the range value represents to modify the motor rotation direction, 1: change direction, 0: default	0-255	0
F17	Select [P] or [F] interface. 1: Off [P] on [F]. 2: On [P] Off [F]. 3: All off	0-3	0
F20	The main interface display content: 0: Absolute position (positive and negative coordinates can be displayed), 1: Absolute position (only positive coordinates are displayed), 2: Relative position, that is, in the current state, the motor stop position is cleared (positive and negative coordinates can be displayed) 3: Output pulse frequency, 4: Motor speed, 5: The distance and speed of the motor, 6: The actual speed value of the controller	0-6	0
F21	Press the return key: 0: The motor stops slowly according to the deceleration 1: The motor stops immediately 2: The motor stops slowly according to the deceleration and automatically returns to zero	0-2	0
F22	Button (start/emergency stop) signal filter time	0-65535	25
F24	reset	0-4	4

## 4.2 Detailed introduction of each **[F]** function

### 4.2.1 [F1 and F2] Setting of electronic gear ratio

Detailed description of the function: The purpose of setting the electronic gear ratio is to keep the value displayed by the system consistent with the value of the actual motor running. If you don't need to display the actual value, you don't need to set it.

Method of displaying distance value:

[F1]: Numerator (electronic gear ratio) How many pulses is equal to one motor revolution

**[F2]** : Denominator (electronic gear ratio) How many  $\mu\text{m}$  is equal to one motor revolution.  $1\text{mm}=1000\mu\text{m}$

(Numerator F1): After simplifying (denominator F2), the value obtained is the value to be filled in, and you can write them separately. Value range 0-65535

The following example:

If the driver is subdivided into 1000, the screw pitch is 5mm. Therefore, it can be concluded that the motor rotates 1 circle = 1000 pulses, and the motor rotates 1 circle actually walks =  $5\text{mm}=5000\mu\text{m}$ . So  $1000:5000=1:5$ , so F1 is filled with 1 and F2 is filled with 5. At this time, the system displays 001.000 is 001.000mm

How to display the number of laps:

For example, the driver is subdivided into 1600, so it can be concluded that: 1 motor revolution = 1600 pulses. If it is required to display 001.000 on the controller to represent one circle, as long as the controller sends out 1600 pulses when the

screen displays 001.000, that is one circle.

## Into the formula:

The actual number of pulses sent by the system =  $\frac{\text{Displayed value} \times 1000}{\text{Denominator}} \times \text{molecular}$

inferred:  $1600 = 001.000 \times 1000 \times \text{molecular} / \text{Denominator}$

After simplification: numerator: denominator=16:10. Get the numerator=16. The denominator=10. At this time, the system displays 001.000, which means a circle!

How to display the angle:

For example, the driver is subdivided into 3200, so it can be concluded that: 1 motor revolution = 3200 pulses. If it is required to display 360.000 on the controller to represent one circle, as long as the controller sends out 3200 pulses when the screen displays 360.000, that is one circle.

Substituting the formula into the formula is: 3200 (drive subdivision) = 360.000 (the value to be displayed by the controller) x 1000 (fixed value) x numerator/denominator.

After simplification: numerator: denominator=2:225. Get the numerator=2. The denominator=225. At this time, the system displays 360.000, which means one lap!

In order to take care of some customers who do not understand the above concepts: there is another simple method: the method of rounding up. That is, let the system go 010.00 and see if it actually goes 10mm. If you actually go more, reduce the value of the numerator of F1, or increase the value of the denominator

of F2. Repeated this several times, you can reach a similar conclusion. The way of angle is the same.

tips:

1: Because the motor is not completely omnipotent, it cannot go from certain angles. Which angles can't be walked? Look at the step angle on the motor nameplate: for example, 1.8 degrees. The 1.8 step angle means that the motor's original movement is 1.8 degrees for 1 time. If you have to walk 30 degrees. That is  $30 \div 1.8 = 16.666$  steps

It can be concluded from this that the motor has to move 16.6 times, but the motor is not allowed to take half a step, so either 16 steps or 17 steps are required! At this time, there is a theoretical error. If a stepper motor of 1.2 degrees can walk accurately:  $30 \div 1.2 = 25$  steps. Therefore, if the angle is used, the three-phase motor (1.2 degrees) is more suitable than the two-phase motor (1.8 degrees).

2: Driver subdivision introduction: Taking 1.8 degrees as an example, a 1.8-degree motor cannot be used in actual situations because the step is too large. For practicality, the driver is optimized: when it is set to 1000 pulse subdivision, it means  $1.8/5 = 0.36$  degrees, and the motor stepping becomes 0.36 degrees, which greatly improves the motor resolution.

3: Summary: The greater the subdivision of the drive, the higher the resolution of the motor, so the accuracy is better, but the speed is slower. Therefore, in actual use, the higher the subdivision, the better. The subdivision is high, the accuracy is

indeed high, but the speed is not fast. The subdivision of the drive should be combined with the actual situation to slowly debug. The general recommendation is 800-3200 subdivision!

#### **4.2.2 [F3 and F4] The minimum and maximum speed limits**

Function detailed introduction: The minimum and maximum speed limits play a motor speed protection function. The purpose is to prevent the possibility of accidents caused by disorderly adjustments.

When the actually set speed [P2 and P4] is lower than the value set by the minimum speed limit [F3], the system will take the minimum speed limit [F3] as the standard!

When the actually set speed [P2 and P4] is higher than the value set by the maximum speed limit [F4], the system will take the maximum speed limit [F4] as the standard!

#### **4.2.3 [F5/F6/F7/F8] Related parameters of motor zero point**

<b>F5</b>	<b>Zero position (only useful when mechanical zero point)</b>
<b>F6</b>	<b>*Zero seek speed (only useful when mechanical zero point)</b>
<b>F7</b>	<b>Zero seeking mode (0: software zero point 1-3: mechanical zero point, the recommended setting is 1)</b>
<b>F8</b>	<b>*Zero function start point (only useful when mechanical zero point)</b>

From the above display, it can be concluded that F5-F6-F8 only work in the mechanical zero mode, and [F7-Zero mode] is used to select mechanical zero or software zero. So here is the introduction of [F7-Zero-finding mode]. In the introduction, the meaning of F5-F6-F8 will be brought in by the way.

#### **【F7-Zero Seeking Mode】**

0: Software zero point: that is, the current position when the system is turned on is

0. In the future, the system will return to this position as a reference. When an error occurs, the system will not be calibrated.

1: Mechanical zero point-mode 1 (recommended): Take the installed [limit switch] as the reference zero point.

Working principle: The motor quickly reverses to zero (the value of [P4]), when it reverses to the zero position (the value of [F5]), the motor speed is switched to the zero speed (the value of [F6]). At this time, the system searches for the limit switch at the zero-seeking speed. When the limit switch is touched, the motor stops and marks it as 0.

Advantages: time saving in the zero return process/installation of limit switch position is arbitrary. Disadvantages: from fast to zero speed (slow speed), there will be a pause

2: Mechanical zero point-mode 2 (not recommended): Take the installed [limit switch] as the reference zero point.

The action is consistent with mode 1. Difference: From fast to zero speed, it will switch smoothly in deceleration mode.

Disadvantages: 1- If the parameter setting is not current, the switching speed will be chaotic. 2-Because of the smooth transition, the zero seek position should be large. Not recommended for use

3: Mechanical zero-mode 3 (not recommended): Take the installed [limit switch] as the reference zero.

The motor quickly reverses to zero (the value of [P4]), and looks for the limit switch.

After touching the limit switch, it becomes the zero-seeking speed (the value of [F6]), and continues to rotate in the direction of the limit switch, reverse Distance: Zero position (value of [F5]), when reverse to zero position, then change to forward rotation, when it leaves the limit switch, it is regarded as zero point.

Advantages: The screw gap can be eliminated, so the accuracy is higher than the above models. Disadvantages: working time is slow, there are requirements for installing limit switches

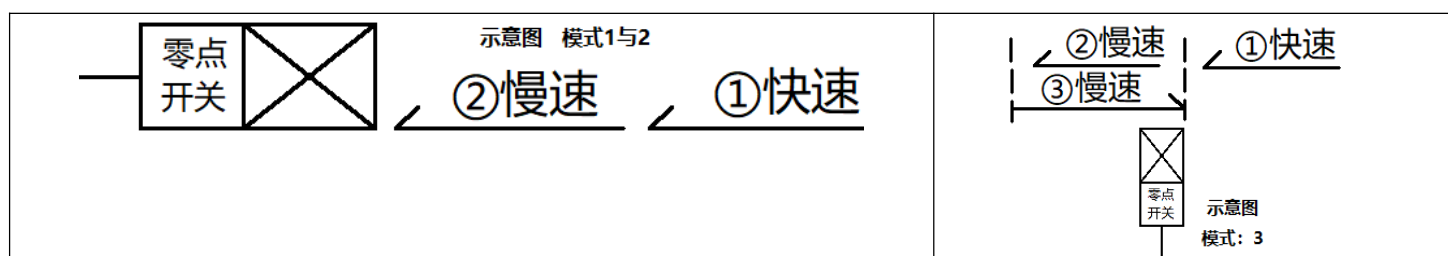

Note: The slower the zero search speed [F6] is set, the higher the calibration accuracy. It is like a car braking, the slower the driving speed, the more stable and accurate the stop!

[F8-Zero function start point]: In what range is the zero limit switch useful. Example: Set to 100.000, which means that the zero limit switch is only useful within the range of 100.00. Even if the zero switch is touched outside the range of 100.00, it will not work.

Example application of setting homing mode 1:

The setting parameters are as follows: [F5] Home position=003.000 [F6] Home speed=00800 [F7] Home mode=1 [P4] Reverse speed=01500. Therefore, it can be concluded that the motor quickly reverses to zero first, and the speed value is [P4]

the reverse value of 1500. When it is 3mm before the zero point sensor (the value of F5), the zero point sensor is decelerated (speed value). For [F6]=800) as shown in the figure below:

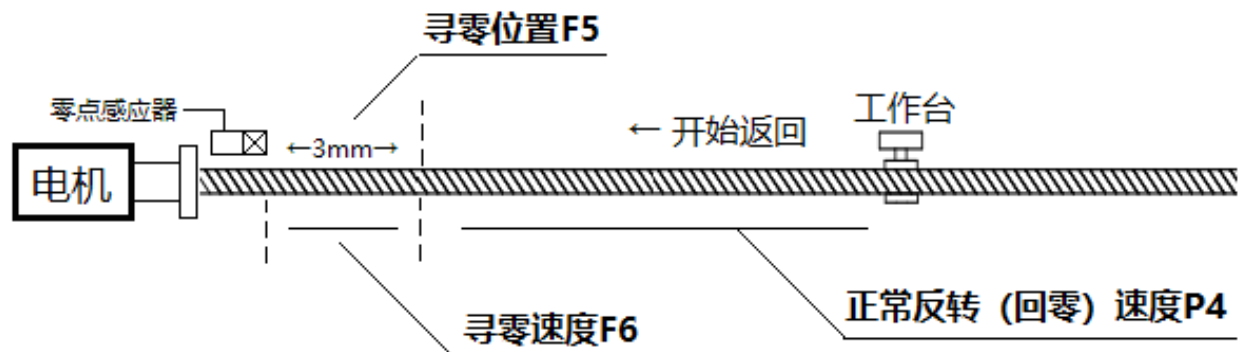

#### 4.2.4 【F9-F10】 Setting of motor acceleration and deceleration

Function detailed introduction: The so-called motor acceleration and deceleration is to make the motor start slowly and stop slowly. It is the same as the acceleration time of a car.

Note: The value set here is the level, and the range is 0-65535. At the same speed: the higher the level value, the faster the acceleration and deceleration. But as the constant speed changes, the acceleration and deceleration will also change accordingly, because the speed becomes faster, the acceleration and deceleration must be increased to the target constant speed correspondingly!

#### 4.2.5 【F13】 【F22】 Input signal filtering time

Function detailed introduction:

F13-X0, X1, X2 input filter time

F22-Key input filter time, that is, all the buttons on the controller panel (including the input port corresponding to the key)

The input signal filtering time is the time a signal is received and must be



maintained for more than that time before the system considers it to be a valid signal. If it is less than the set time, the system considers it as an invalid signal. The purpose is to be suitable for various interference occasions. The larger the set value, the longer the input time that needs to be maintained, and the better the anti-interference ability!

#### **4.2.6 【F14】 Amplitude value of speed change during operation**

Function detailed introduction: When the motor is running, the current running speed can be modified through the knob (encoder) on the panel. The amplitude of the speed change of the knob is determined by this parameter. The larger the value, the more the speed will be changed by turning the knob once! It is recommended that the smaller the better (the more stable).

Note: 1: The speed change function can be forcibly closed in 【F16】 . 2: The speed after the speed change is not saved when the power is off by default. If you want to save after power off, in the standby state, press the [Set/Return] key to save. At this time, the screen will display SPEED-SAUE

#### **4.2.7 【F15】 Does it return to zero automatically when it is turned on?**

Detailed description of the function: After each power-on, will it automatically return to zero after power-on? 0: No return to zero after power-on, 1: Automatically return to zero after power-on

Note: If the automatic zero return is set at power-on, under the default setting, the zero return uses the software zero point. The mode needs to be set under the

function [F5-F8]. If the mechanical zero point is set, it is recommended to set the zero return to the mechanical zero point (mode 1) for the best effect!

#### **4.2.8 [F16] \*Special function setting**

Detailed introduction of functions: some functions are still in the experimental stage or rarely used, here as centralized processing. Turn it on when you really need it.

This value must be converted to binary before it can be used. For example, the value is 2, converted to binary: 0000 0010. 1 means open. 0 means off.

All 0-Normally do not open any special function (default value) 1st digit from the bottom-Forced to close the speed change function 1-Turn off the speed change 0-Turn on the speed change

Second from the bottom-modify the direction of motor rotation 1- change direction 0- default direction

3rd from the bottom-turn on RS485 communication (follow the MODBUS-RTU protocol). The protocol specification can be downloaded from the official website.

Example: Now you want to forcefully close the speed change function and change the direction of motor rotation. Turn on the 1st and 2nd from the bottom. So the binary is 0000 0011. Converted to decimal: 3. So the final value is 3.

#### **4.2.9 [F17] Selectively switch P interface or F interface**

Detailed function introduction: In order to prevent accidental misoperation, the function menu P interface or F interface can be selectively hidden

1-OFF【P】ON【F】2-ON【P】OFF【F】3-All closed (temporarily open: press the【Settings】

key before turning on)

#### **4.2.10 [F18] Multiple PSC of motor running speed**

Function detailed introduction: Modify the speed multiple when the motor is running. The larger the value, the slower the speed.

This is like a car's gear position. With the engine speed unchanged, the higher the gear position (the smaller the value), the faster the speed. Default value: 3. The purpose of this parameter is to adapt to some special occasions. If the motor requires super slow work (only one revolution a day, etc.).

#### **4.2.11 [F19] Acceleration and deceleration multiples**

Detailed description of the function: (used in special circumstances, generally do not need to be set) In some occasions, special fast acceleration and deceleration are required. At this time, a large acceleration and deceleration value is required (the larger the value, the faster the acceleration and deceleration). By default, the value of F9: acceleration or F10: deceleration will not be large enough. In order to increase the value of acceleration and deceleration, there is a multiple. This is a compromise method not to affect the experience of most customers, but to solve special requirements.

The final acceleration and deceleration value = (F9: acceleration or F10: deceleration value) X (the value)

#### **4.2.12 [F20] Main interface display content**

Detailed description of the function: During operation, the content mode of the LED digital tube display.

0-Absolute position (positive and negative coordinates can be displayed) where "-" means reverse. Unit: circle or distance value or angle. The display meaning of the value is completely determined by the value of 【F1】 【F2】 . Calculate [F1] [F2] in advance and the value will be displayed accurately

1- Absolute position (only positive coordinates can be displayed). Calculate the 【F1】 【F2】 in advance, the value will be displayed accurately.

2- Relative position. That is, the current status is displayed, and the motor is cleared when it stops (positive and negative coordinates can be displayed). The display "-" means reverse.

3- Output pulse frequency (unit: KHZ) Maximum error:  $\pm 1$ KHZ, theoretical maximum frequency: 85Khz

4-Motor lap speed (unit: rpm, maximum error  $\pm 90$  rpm. Need to fill in the actual driver subdivision number in [F1, otherwise the display is incorrect])

5-Motor walking distance speed (unit: mm/sec, the maximum error is  $\pm 2$ mm/sec. The value of [F1] [F2] needs to be calculated in advance, otherwise the display is incorrect)

6- The actual speed value of the controller (that is, the value of [P2] [P4]) Unit: level

7- The value of the forward rotation delay (that is, the value of [P6]) unit: second

8-Reverse end delay value (that is, the value of [P7]) unit: second

9-Working times display (not saved after power off) Unit: times Maximum times: 99999 After exceeding, "-----" will be displayed

#### **4.2.13 【F21】 Press the return ESC (emergency stop) key action**

Function detailed introduction: During work, the motor stop mode after pressing the [Emergency Stop] key.

0-The motor stops slowly according to the deceleration (if it is in the deceleration state, it stops immediately) 1-The motor stops immediately (with impact)

2- The motor stops slowly according to the deceleration and automatically returns to zero. Press again to pause and return to zero. Press it again, it will return to zero again, and cycle in turn

#### **4.2.14 【F24】 Restore factory settings**

1-Restore only 【 F 】 parameters 2-Restore only 【 P 】 parameters 3-Restore all (recommended) 4-No need to restore

0 or >10: restore everything and turn on the self-check mode, factory mode (only for manufacturers, users do not set this parameter)

Note: After changing this parameter, you need to power off and restart to take effect